

PROFILES

DURON

uPVC Windows & Door Systems

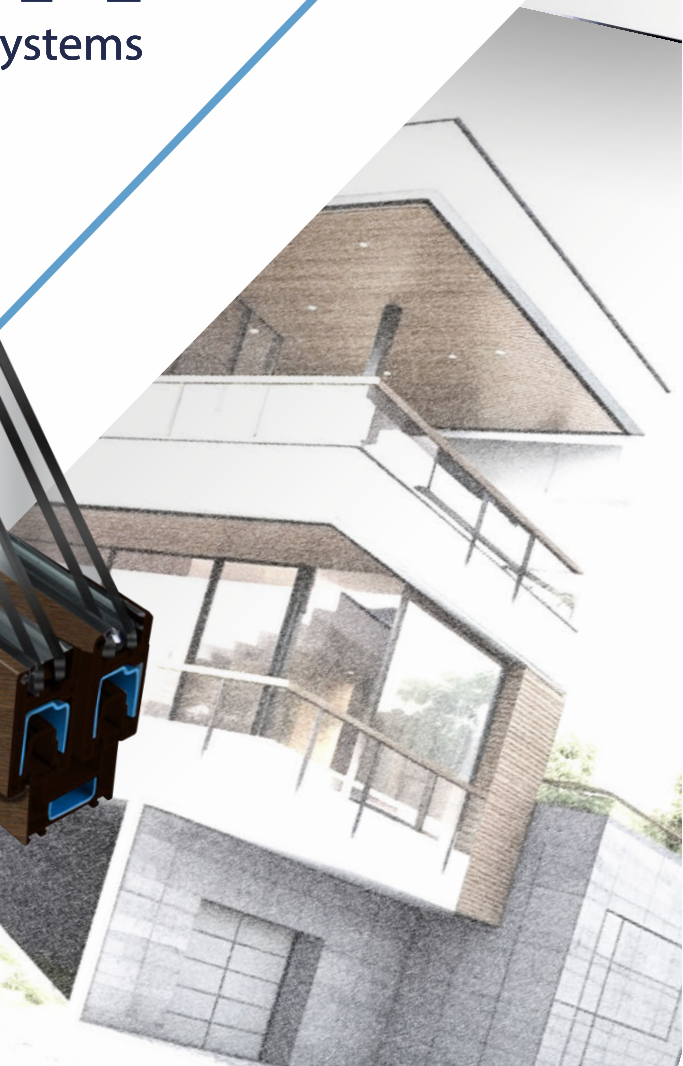

ADVANTAGE DURON

DURON is a brand promoted by a group of companies which have been leaders in the Indian fenestration industry for the last 20+ years. Over the years the demand for uPVC windows and doors have increased many folds due to discerning homeowners wanting better and more sustainable options. DURON has a wide range of high quality uPVC profiles for a variety of uses, including for windows, doors, and other building components. Our uPVC profiles are designed to provide excellent performance, ensuring the durability and affordability for a variety of projects. Understanding the changing preferences towards the use of unplasticised polyvinyl chloride (uPVC) frames for doors and windows, we have backwardly integrated and set up an extrusion plant to produce world class uPVC profiles to make doors and windows. We draw on the immense experience of the senior team in plastic engineering and extrusion technology, to offer a portfolio that has the most innovative profile systems conducive to India's varied climatic conditions and customer preferences.

DESIGN FLEXIBILITY

DURON offers an advanced range of window styles that can be mixed and matched for new buildings and replacement applications. All styles, from inward to outward opening, single windows to multi light windows with transoms, balcony doors, sliding windows and doors. All combinations can be constructed with DURON systems. Whether it is a folding door or a French door, a tilt and turn or an arched window you are looking for, with DURON window systems the possibilities are virtually unlimited.

Design technology & formulation from Germany

Profile extrusions as per BS EN 12608-1:2016 European standards

Flexible 39, 50, 60 & 112 mm Series profiles available

Tested for water penetration, air infiltration & wind pressure.

Glazing Thickness from 5-24 mm glass

Interlock profile with brush seal option for smooth cushioning effect while closing slider

Double Fin Seal separate sash cover options for better sealing performance

High percentage of Titanium Dioxide for greater UV resistance

Villa Windows Grill & Vertical slider profiles are also available.

PRODUCT FLEXIBILITY

The choice of a profile should not be based on just the dimension of the profile sizes alone. It should be based on the combination of various technical elements and chemical properties that can withstand climatic conditions of the building site. Our profile sizes are available in premium and heavy, mid and regular, sleek and economical section sizes.



The image is a collage of industrial scenes. The top left shows a worker in a dark shirt and cap operating machinery. The middle section features a large, complex piece of industrial equipment with multiple rollers and corrugated hoses. The bottom right shows a person in a white lab coat and blue gloves using a tablet device. The background is a bright blue gradient with white geometric shapes.

Total Quality Management

The production facility has machinery that uses the newest extrusion technology. The dimensional accuracy combined with our custom formulation is supported with online and offline testing systems that ensure zero defect profiles. Our quality is certified by outside agencies also.

**LET LOOSE YOUR
IMAGINATION**

**DURON
WINDOWS & DOORS
SYSTEMS**

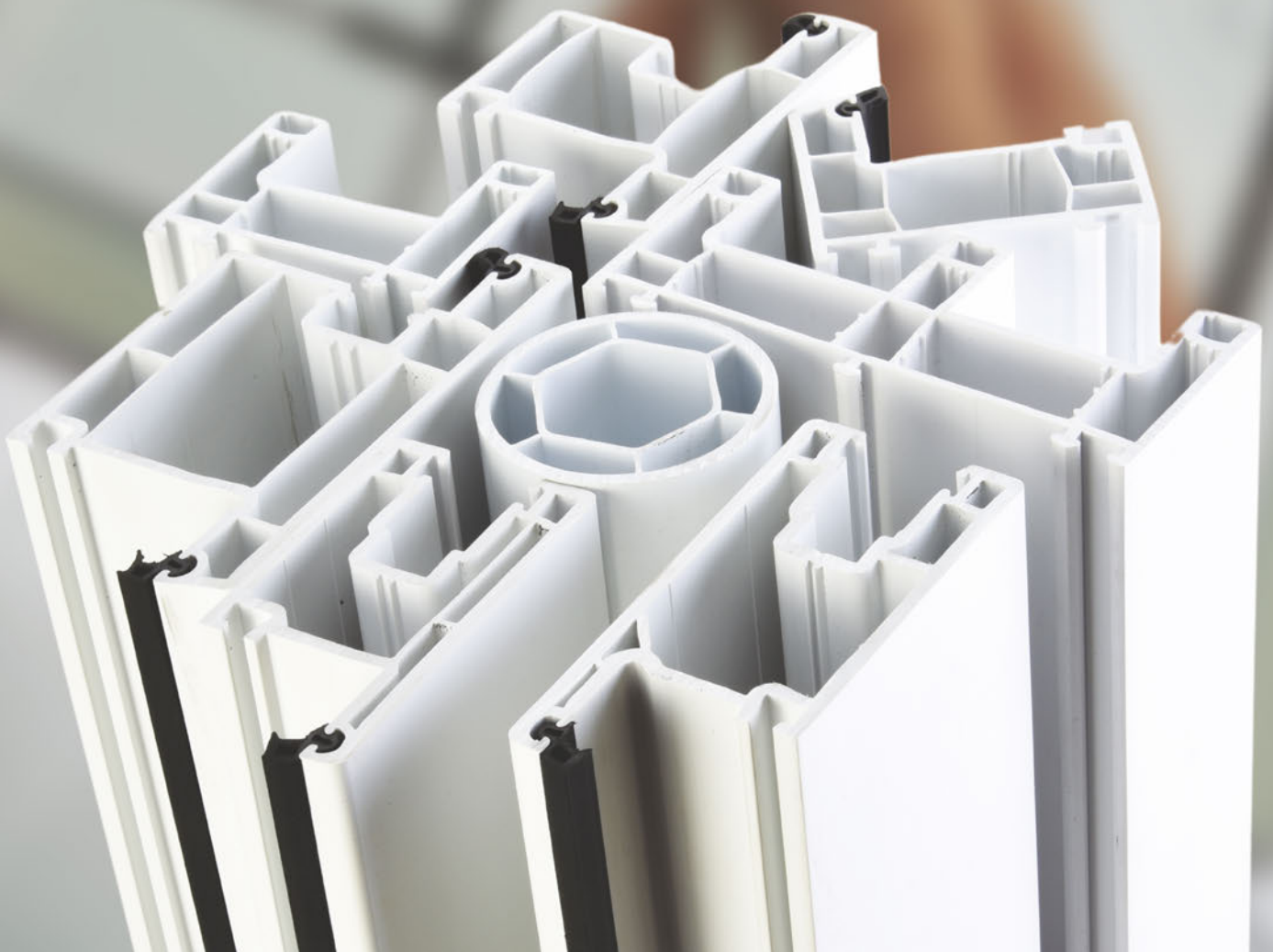

WINDOWS



Tilt & Turn



Casement



Sliding



Top Hung



Villa



Casement



Slide & Fold Doors



Sliding

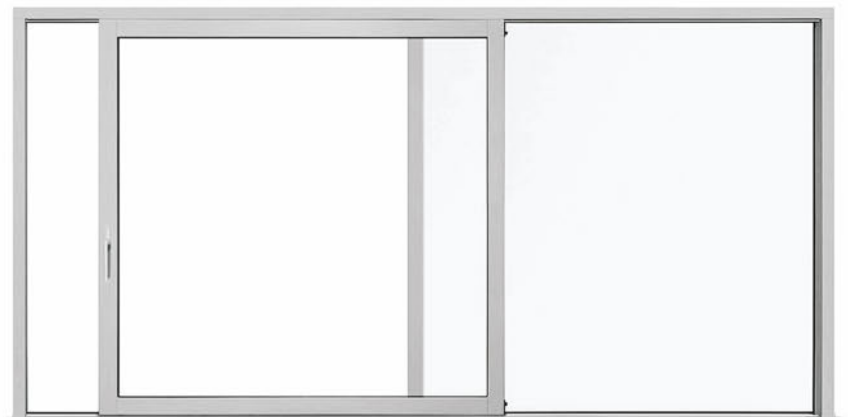

Lift & Slide

DOORS



COLOURS

COLOUR CHOICE

The touch of colour has an elegance that is preferred by discerning homeowners and interior designers, to match the other aesthetics and ambience of the space. Without having to cut down trees and damage the environment, we offer the elegance of wood on all our profile sizes. The high quality laminates, by RENOLIT, are applied with sophisticated machinery using a two-staged anti-peel application technology using glue by KLEIBERIT,



Rustic Oak

Golden Oak

Mahagony



Black Smooth

White

Anthracite Grey

TECHNICALS

Casement 60 Series

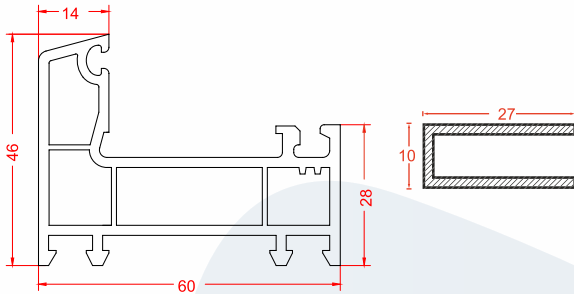
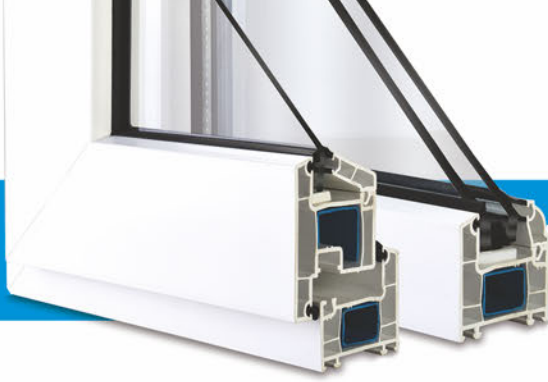

Name: Casement Frame 28mm | Code: CWH60-01
Weight: 0.87 kg/m Pkt Qty: 4 pcs

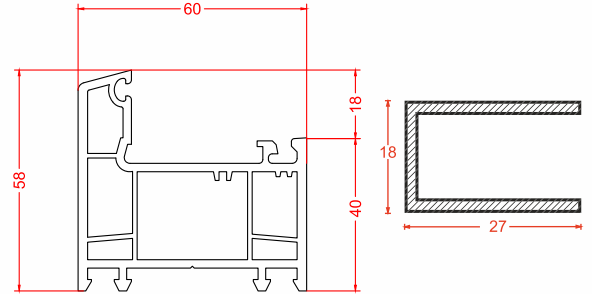

Name: Casement Frame | Code: CWH60-02
Weight: 1.05 kg/m Pkt Qty: 4 pcs

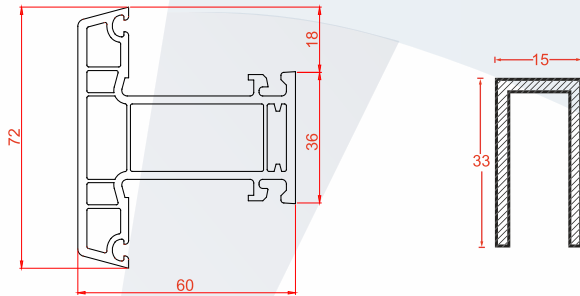

Name: Casement Mullion | Code: CWH60-05
Weight: 1.15 kg/m Pkt Qty: 6 pcs

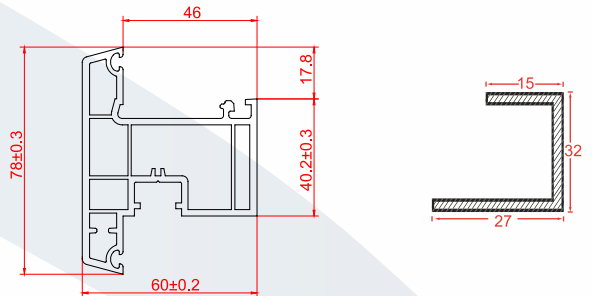

Name: Outward Window Sash | Code: CWH60-03
Weight: 1.21 kg/m Pkt Qty: 4 pcs

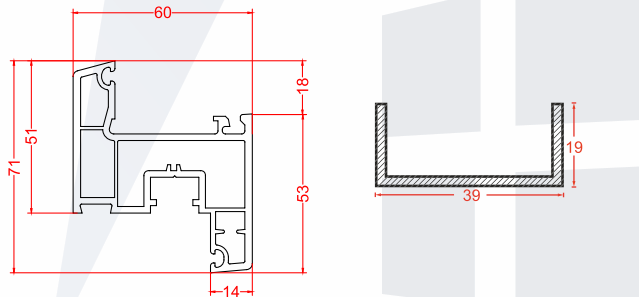

Name: Inward Window Sash | Code: CWH60-04
Weight: 1.15 kg/m Pkt Qty: 6 pcs

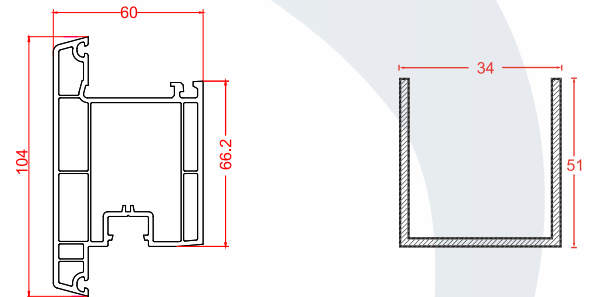

Name: Outward Door Sash | Code: CWH60-06
Weight: 1.51 kg/m Pkt Qty: 4 pcs

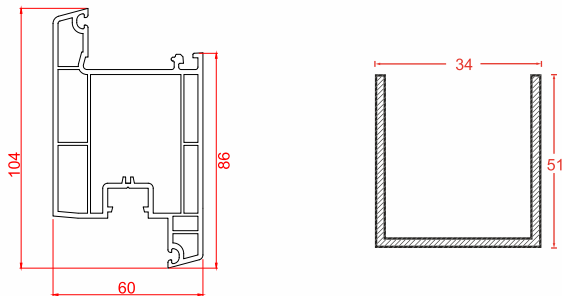

Name: Inward Door Sash | Code: CWH60-07
Weight: 1.54 kg/m Pkt Qty: 4 pcs

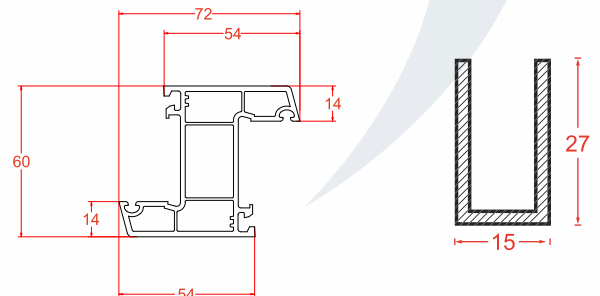

Name: Z Mullion | Code: CWH60-11
Weight: 1.06 kg/m Pkt Qty: 6 pcs

Casement 60 Series

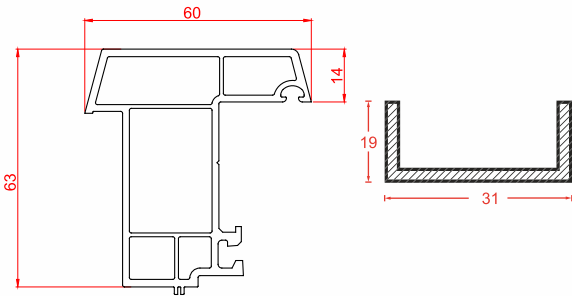

Name: Fly Mullion | Code: CWH60-12
Weight: 0.85 kg/m Pkt Qty: 6 pcs

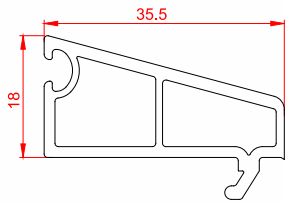

Name: Casement 6 mm Beading | Code: CWH60-08
Weight: 0.32 kg/m Pkt Qty: 25 pcs

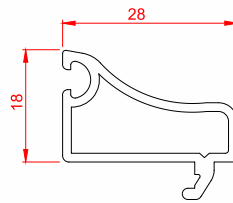

Name: Casement 12 mm Beading | Code: CWH60-09
Weight: 0.24 kg/m Pkt Qty: 30 pcs

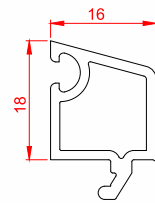

Name: Casement 24 mm Beading | Code: CWH60-10
Weight: 0.19 kg/m Pkt Qty: 40 pcs



DURON
uPVC Windows & Door Systems

All profiles are available in these colours



Whitest White

and



Rustic Oak



Mahogany



Golden Oak



Anthracite Grey



Black Smooth

All profiles and beading are with co-ex gaskets.

TECHNICALS

Sliding 60 Series

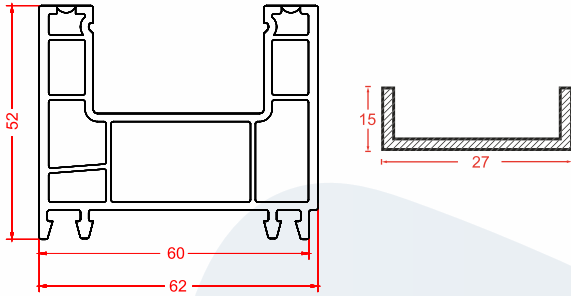

Name: Two Track | Code: SWH60-01
Weight: 1.02 kg/m Pkt Qty: 6 pcs

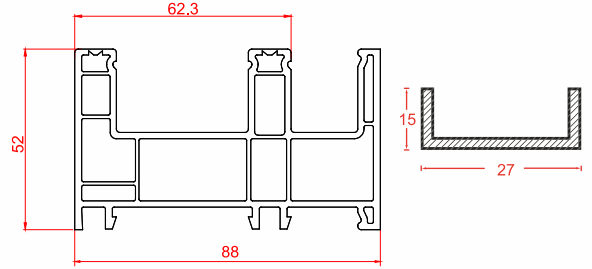

Name: 2.5 Track | SWH60-16
Weight: 1.36 kg/m Pkt Qty: 4 pcs

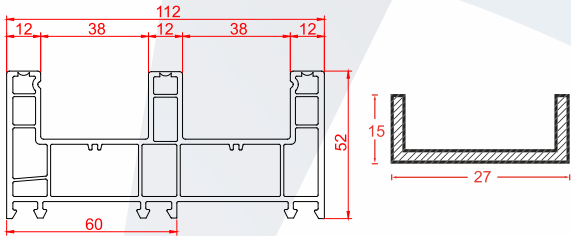

Name: Three Track | Code: SWH60-02
Weight: 1.71 kg/m Pkt Qty: 4 pcs

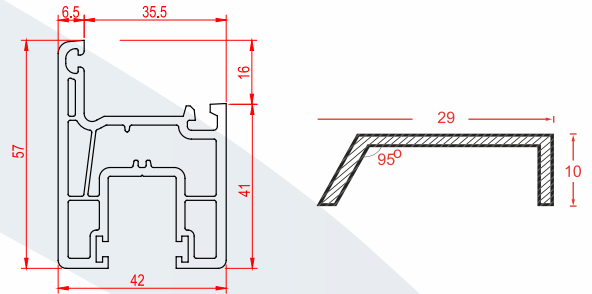

Name: Sliding Sash 57mm | Code: SWH60-03
Weight: 0.90 kg/m Pkt Qty: 8 pcs

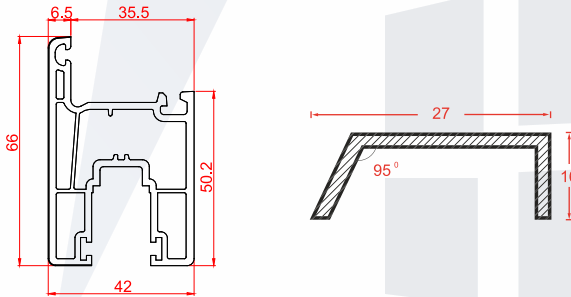

Name: Sliding Super Sash 66mm | Code: SWH60-04
Weight: 1.03 kg/m Pkt Qty: 6 pcs

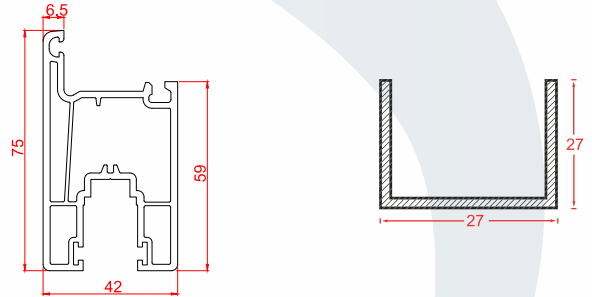

Name: Sliding Door Sash 75mm | Code: SWH60-05
Weight: 1.11 kg/m Pkt Qty: 6 pcs

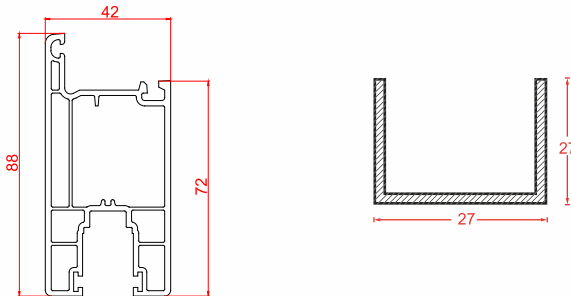

Name: Sliding Mega Sash 88mm | Code: SWH60-06
Weight: 1.25 kg/m Pkt Qty: 4 pcs

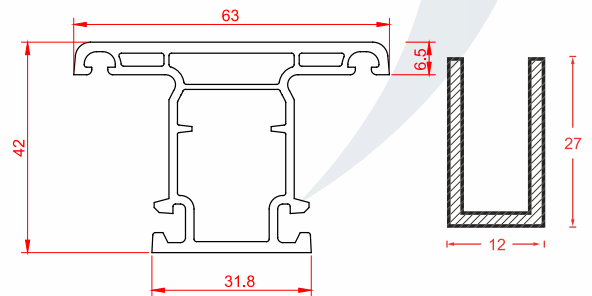

Name: Sliding Mullion | Code: SWH60-07
Weight: 0.80 kg/m Pkt Qty: 8 pcs

Sliding 60 Series

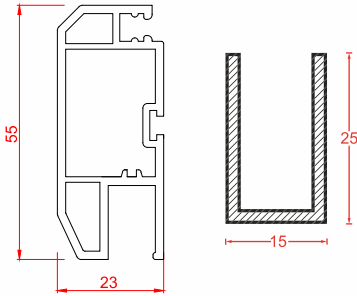

Name: Fly Mesh Sash | Code: SWH60-17
Weight: 0.48 kg/m Pkt Qty: 12 pcs

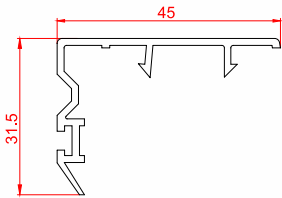

Name: Sliding Sash Interlock
Code: SWH60-08
Weight: 0.23 kg/m
Pkt Qty: 25 pcs

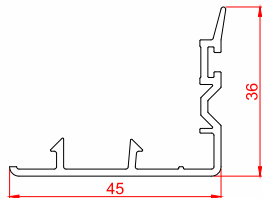

Name: Sliding Super Sash Interlock
Code: SWH60-09
Weight: 0.24 kg/m
Pkt Qty: 25 pcs

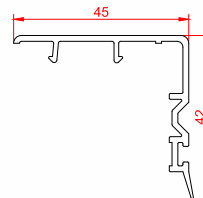

Name: Sliding Door Sash Interlock
Code: SWH60-10
Weight: 0.26 kg/m
Pkt Qty: 25 pcs

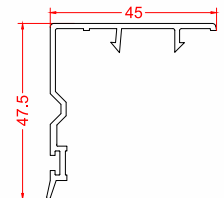

Name: Sliding Mega Sash Interlock
Code: SWH60-11
Weight: 0.28 kg/m
Pkt Qty: 25 pcs

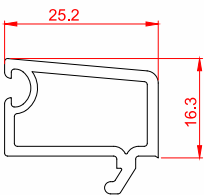

Name: Sliding 6mm Beading
Code: SWH60-12
Weight: 0.26 kg/m
Pkt Qty: 25 pcs

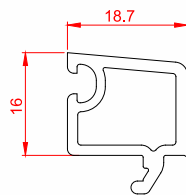

Name: Sliding 12mm Beading
Code: SWH60-14
Weight: 0.23 kg/m
Pkt Qty: 25 pcs

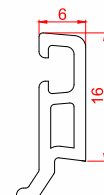

Name: Sliding 24mm Beading
Code: SWH60-13
Weight: 0.135 kg/m
Pkt Qty: 40 pcs

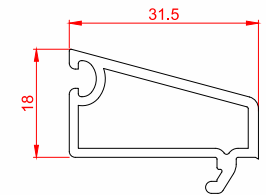

Name: Sliding Mesh Beading
Code: SWH60-15
Weight: 0.28 kg/m
Pkt Qty: 20 pcs



DURON
uPVC Windows & Door Systems

All profiles are available in these colours



Whitest White

and



Rustic Oak

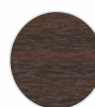

Mahagony



Golden Oak



Anthracite Grey

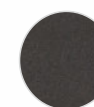

Black Smooth

All profiles and beading are with co-ex gaskets.

TECHNICALS

Auxiliary Profile 60 Series

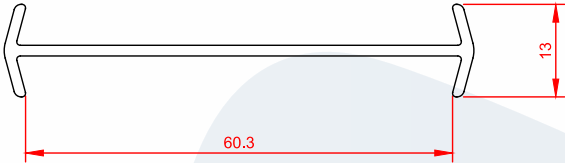
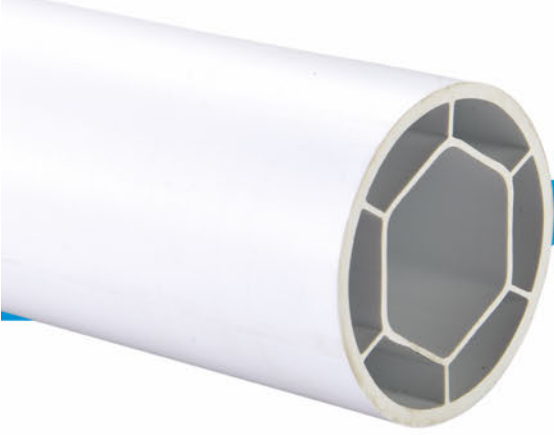

Name: Mini Coupling | Code: AWH60-01
Weight: 0.20 kg/m | Pkt Qty: 20 pcs

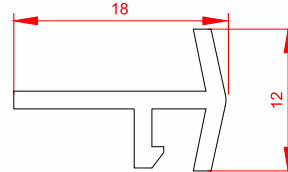

Name: T Joint Coupling | Code: AWH60-07
Weight: 0.08 kg/m | Pkt Qty: 50 pcs

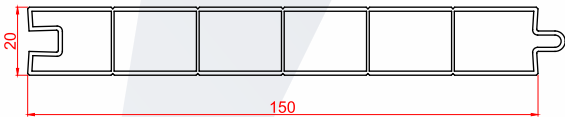

Name: Infill Sash Panel | Code: AWH60-08
Weight: 0.70 kg/m | Pkt Qty: 6 pcs

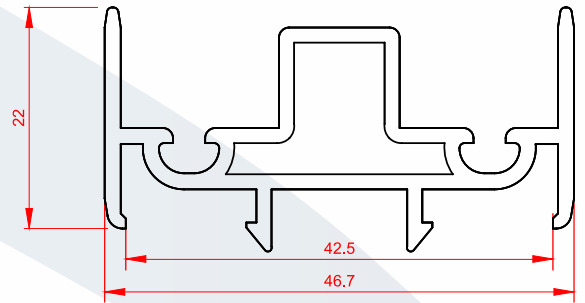

Name: Infill Sash Panel | Code: AWH60-09
Weight: 0.39 kg/m | Pkt Qty: 20 pcs

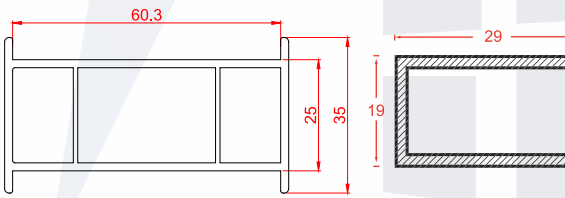

Name: Heavy Duty Coupling | Code: AWH60-06
Weight: 0.53 kg/m | Pkt Qty: 6 pcs

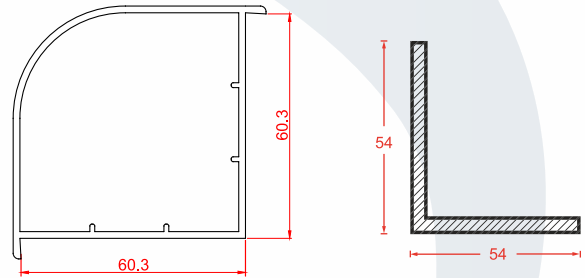

Name: 90 Degree Coupling | Code: AWH60-02
Weight: 0.65 kg/m | Pkt Qty: 4 pcs

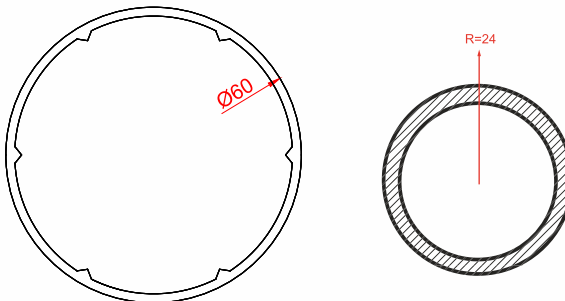

Name: Bay Pole | Code: AWH60-04
Weight: 0.50 kg/m | Pkt Qty: 7 pcs

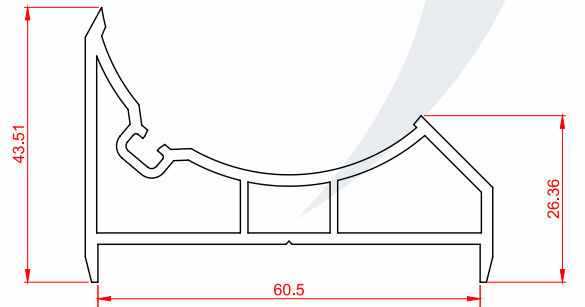

Name: Bay Pole Adaptor | Code: AWH60-05
Weight: 0.50 kg/m | Pkt Qty: 8 pcs

Sliding 50 Series

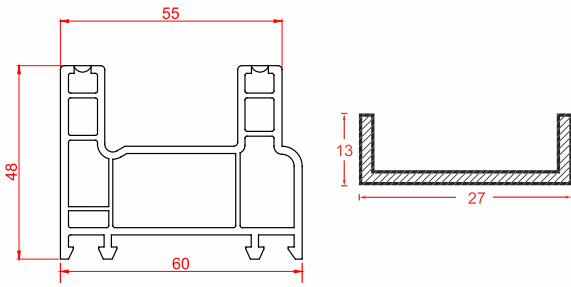

Name: Two Track (50) | Code: SWH50-01
Weight: 0.93 kg/m Pkt Qty: 6 pcs

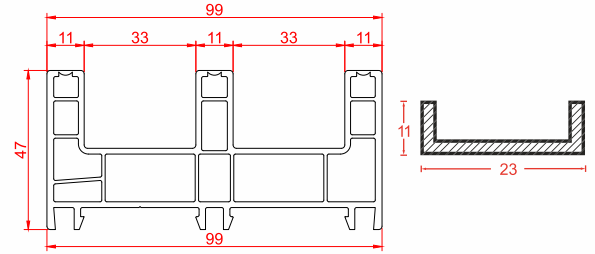

Name: Three Track (50) | Code: SWH50-02
Weight: 1.35 kg/m Pkt Qty: 4 pcs

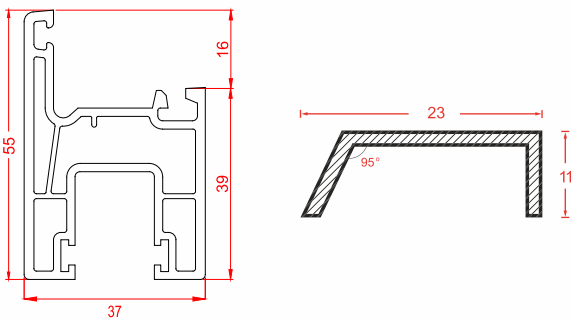

Name: Sliding Sash 55mm | Code: SWH50-03
Weight: 0.73 kg/m Pkt Qty: 8 pcs

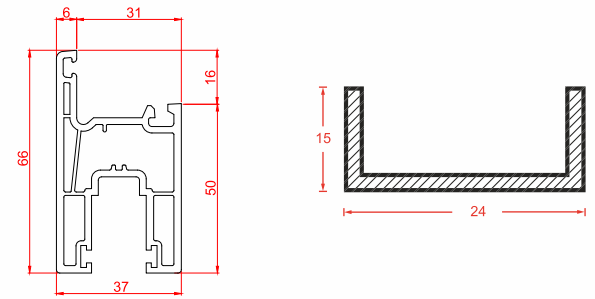

Name: Sliding Super Sash 66mm | Code: SWH50-04
Weight: 0.98 kg/m Pkt Qty: 6 pcs

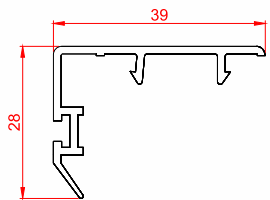

Name: Sliding Sash Interlock (50) | Code: SWH50-06
Weight: 0.20 kg/m Pkt Qty: 25 pcs

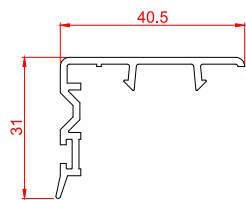

Name: Sliding Super Sash Intelock | Code: SWH50-07
Weight: 0.23 kg/m Pkt Qty: 25 pcs

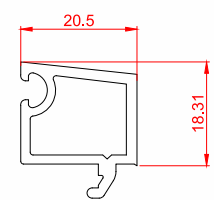

Name: Sliding 6mm Beading | Code: SWH50-05
Weight: 0.25 kg/m Pkt Qty: 25 pcs



DURON
uPVC Windows & Door Systems

All profiles are available in these colours



Whitest White Rustic Oak Mahogany Golden Oak Anthracite Grey Black Smooth

All profiles and beading are with co-ex gaskets.

We commit to making the world greener and aim to bring the latest upgrades in technologies that leave the smallest possible carbon footprint. Stringent quality control and safety guidelines ensure that our products comply with the highest international manufacturing standards that are environmentally friendly. The profiles are made of stabilized UV resistant virgin materials that are lead free, adding a green value to your space. The production wastage is recyclable and so are the windows and doors at the end of their very long life cycle. The use of uPVC for frameworks drastically reduces the use of wood and gives better thermal insulations. This in turn cuts down on the energy consumed, along with the heat and gas emissions, due to reduced requirements for heating and cooling.



green



www.duronupvc.com

+91 8800114583 | info@duronupvc.com

Duron Polyvinyls Pvt. Ltd.

Khasra # 4651 / 279

Daulatabad Road, Gurugram, Haryana